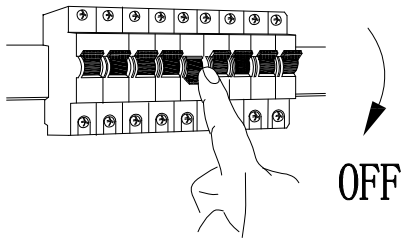
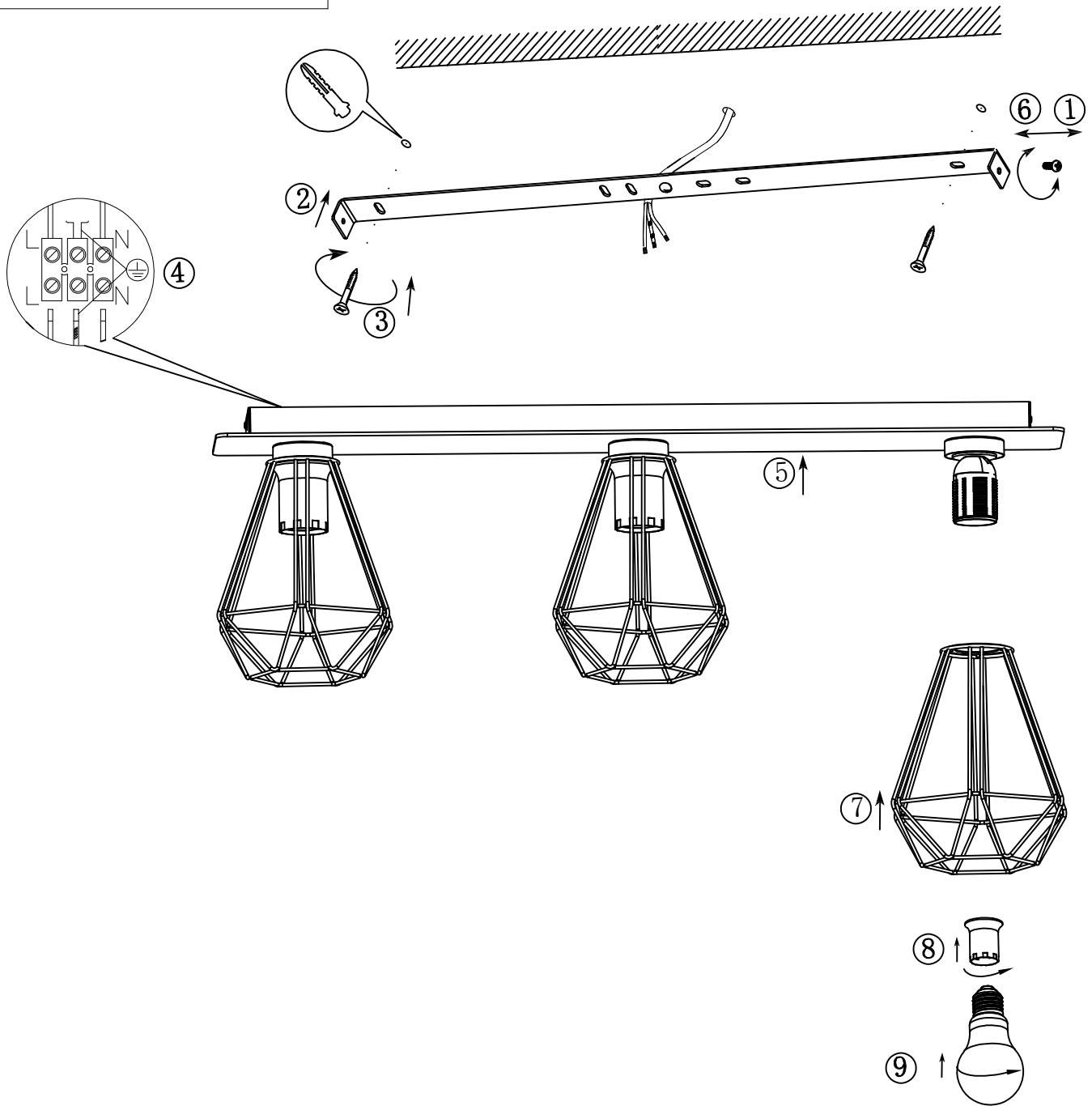
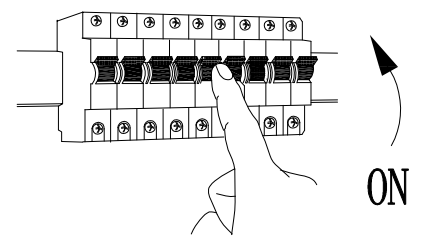

A**B****C**

BLA43655
www.eglo.com